

# SCOREL

Notice de montage  
 Mounting instruction  
 Montageanleitung

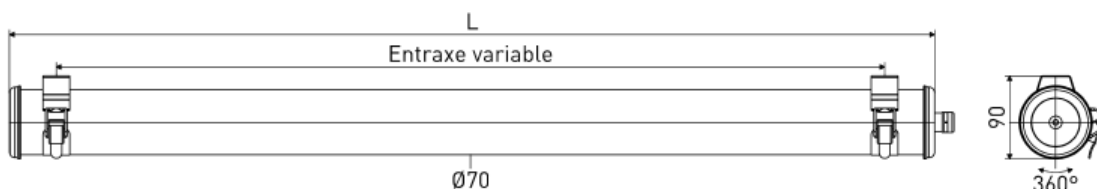

**Sammode**

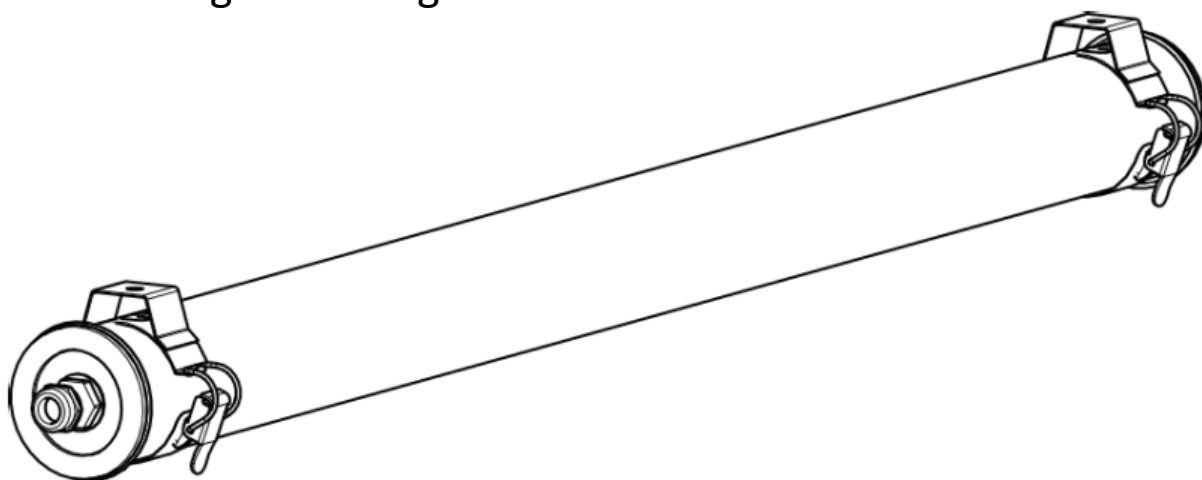

**Ne pas ouvrir sous tension**  
**Do not open when energized**  
**Nicht unter Spannung öffnen**

SI option :

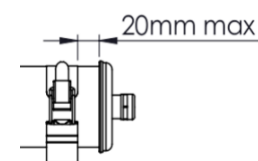

	Ø (mm)	L (mm)	Entraxe max (mm)	SI option ( sensor )		Poids (kg)
				L (mm)	Entraxe max (mm)	
SCOREL	70	715	635	800	720	1,3
SCOREL	70	995	915	1080	1000	2
SCOREL	70	1275	1195	1360	1280	2,7
SCOREL	70	1560	1480	1645	1565	3,5

# Installation & raccordement / Wiring / Verkabelung

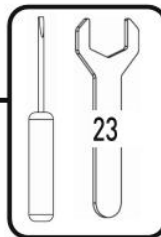

- 
- 
- 
- 
- 
- 
- 
- 
- 
-

# Maintenance

Maintenance / Wartung

5



Ne pas ouvrir sous tension  
Do not open when energized  
Nicht unter Spannung öffnen

1.

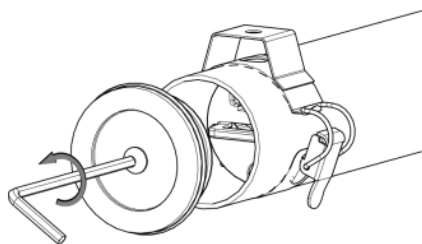

2.

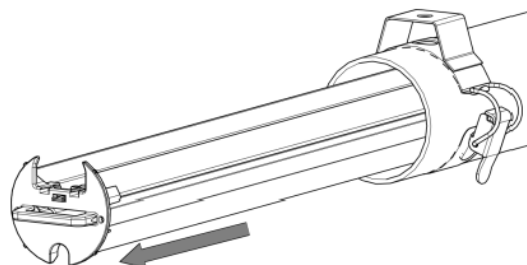

3.

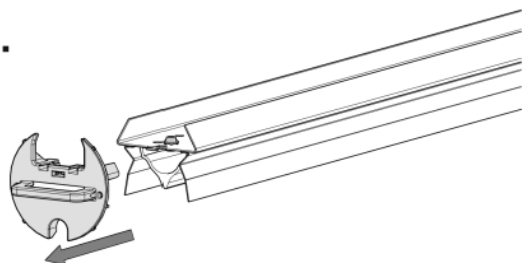

4.

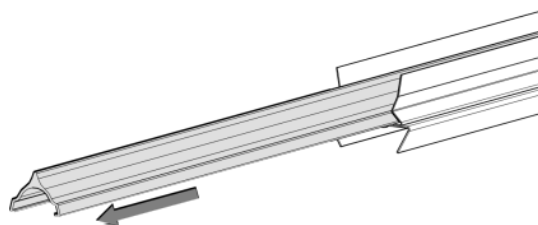

5.

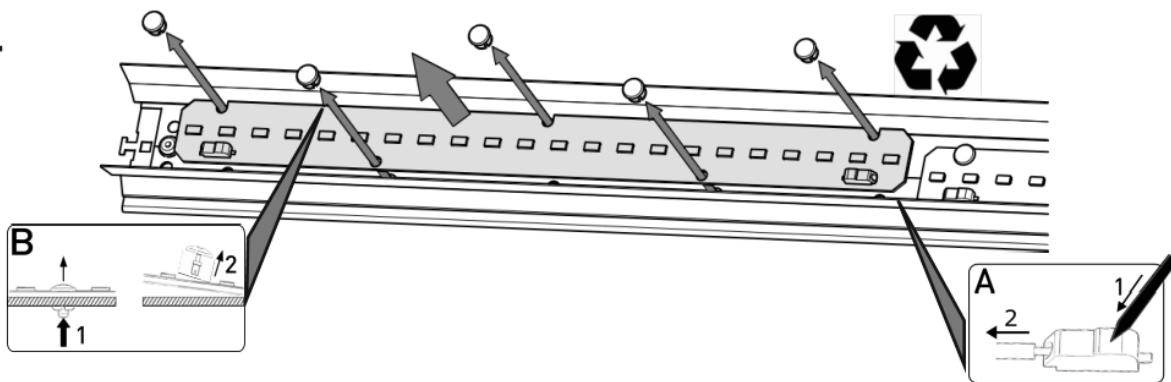

6.

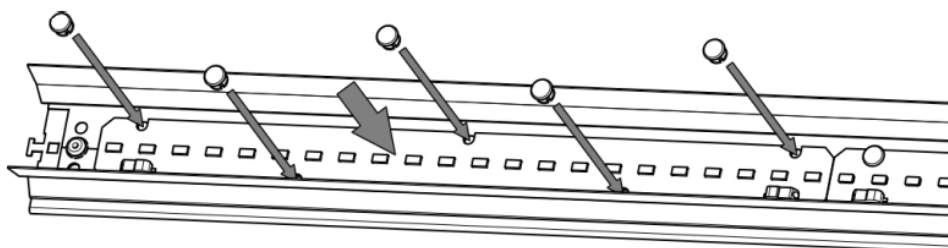

7.

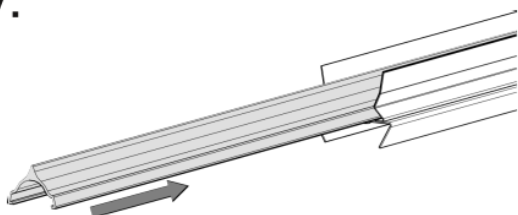

8.

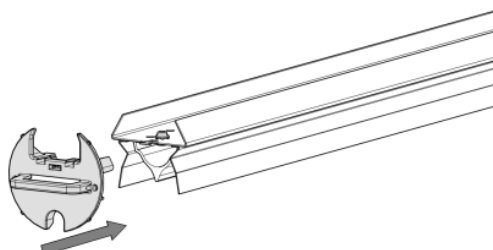

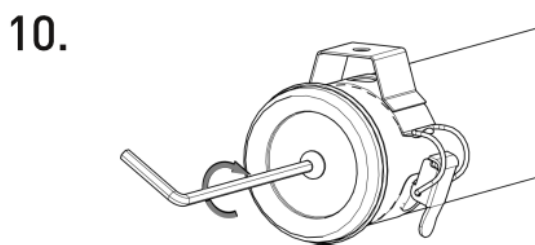
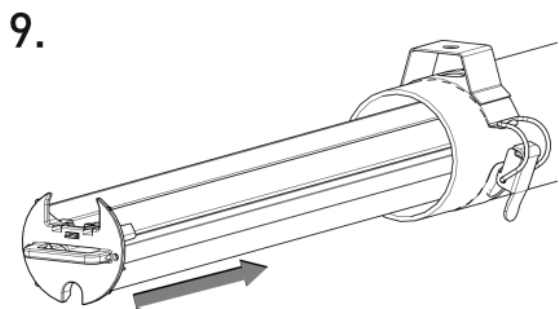

## 1. Flasques / Ends caps / Endkappen

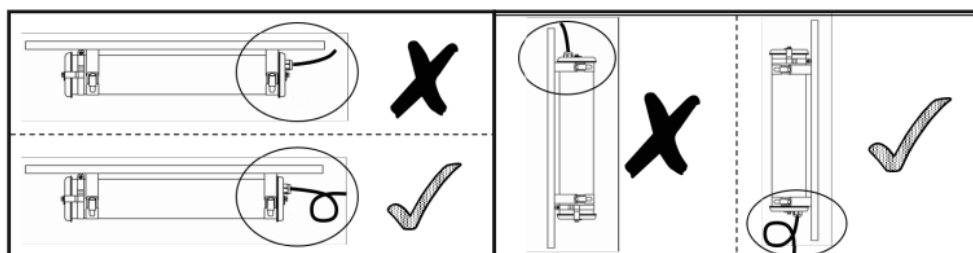

## 2. Position & câble / Position & cable / Position & Kabel

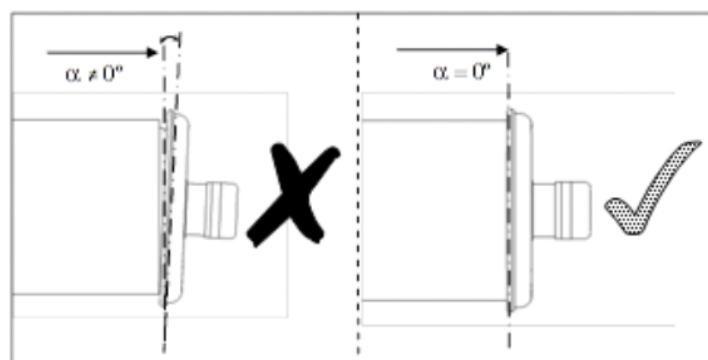

## 3. Joint d'étanchéité / Gasken / Dichtung

