

KIT DE SORTIE MURALE

Box for electrical connection



Sammode

Notice de montage

Mounting instruction

**Pour boîte de
raccordement**



For flush-mounted wall box

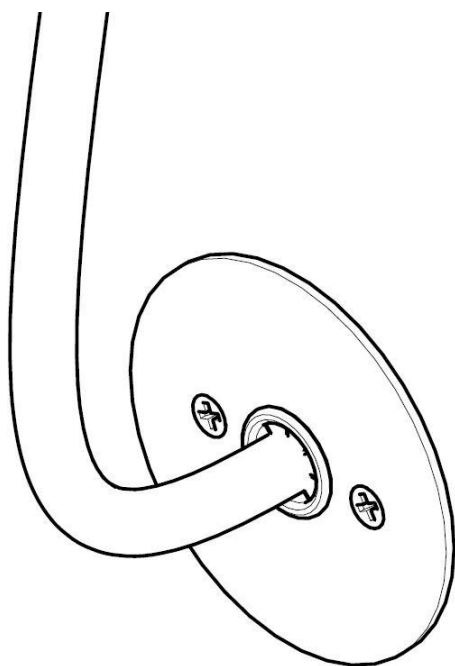

En saillie

Surface mounted

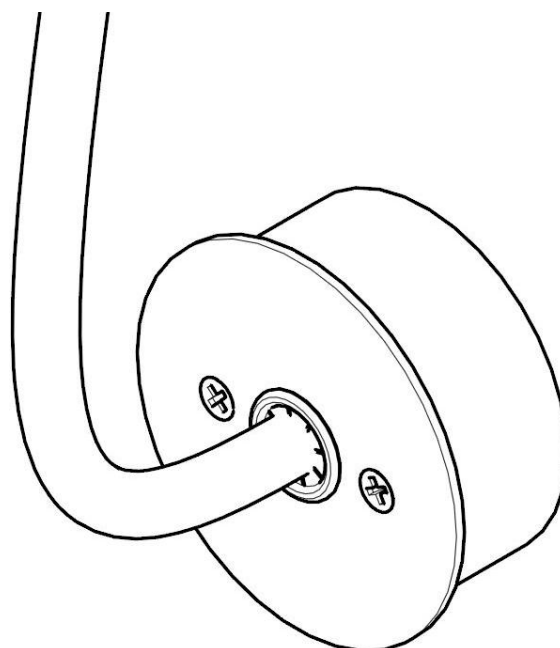

ou
or



Ne pas ouvrir sous tension
Do not open when energized

Sur boîte de raccordement

On flush-mounted wall box

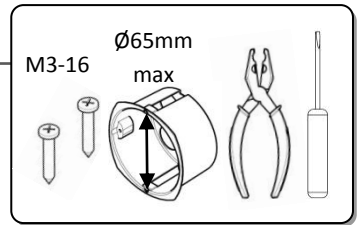
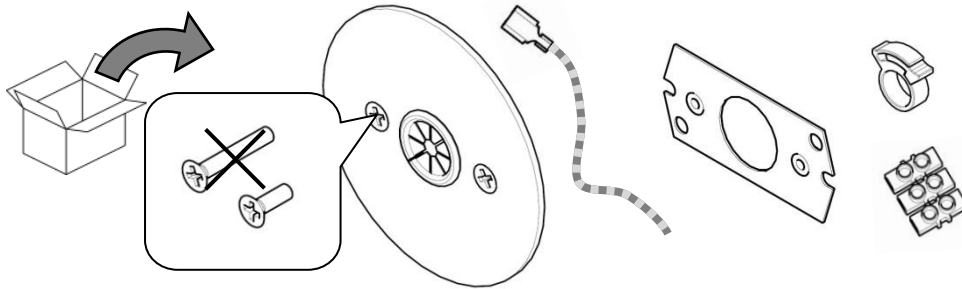

■ Préparation du câble

Cable preparation

1.

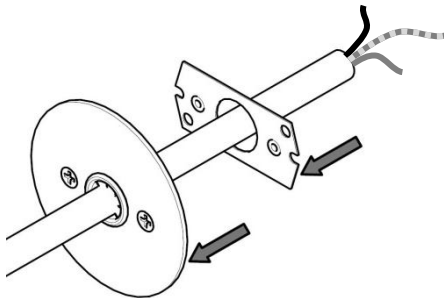

2.

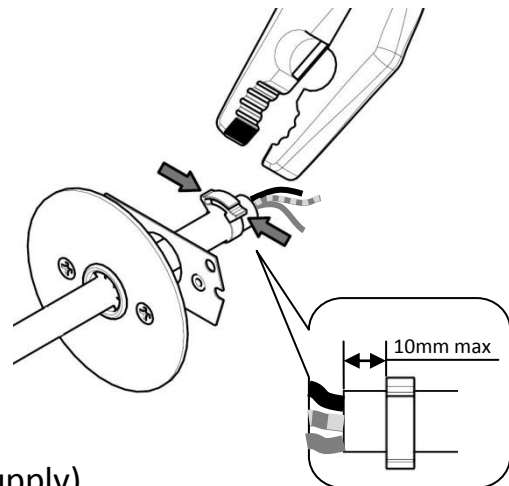

■ Raccordement (hors-tension)

Electrical connection (switch off power supply)

3.

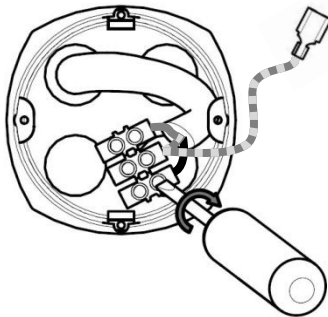

4.

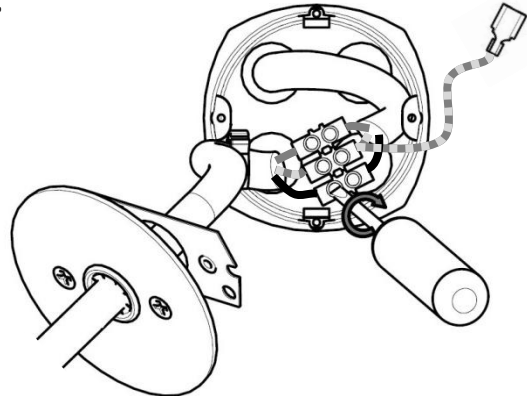

5.

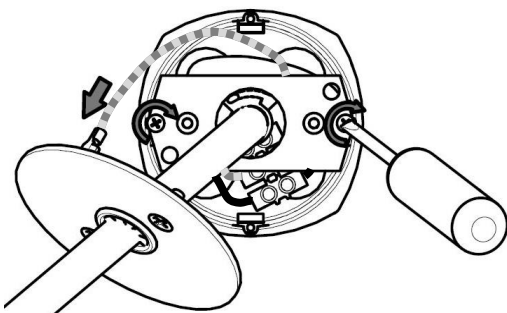

6.

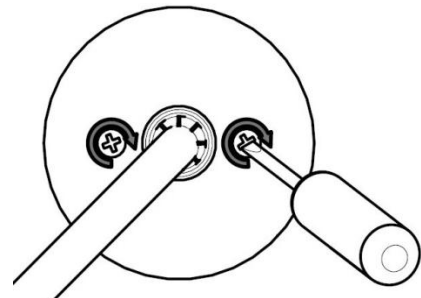

En saillie (mur en béton, pierre ...)

Surface mounted

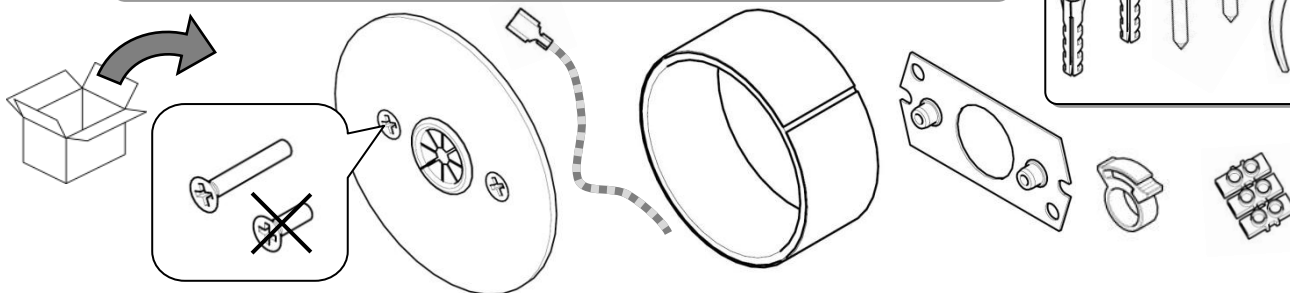
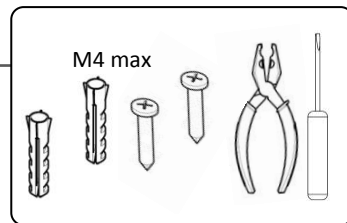

■ Préparation du câble

Cable preparation

1.

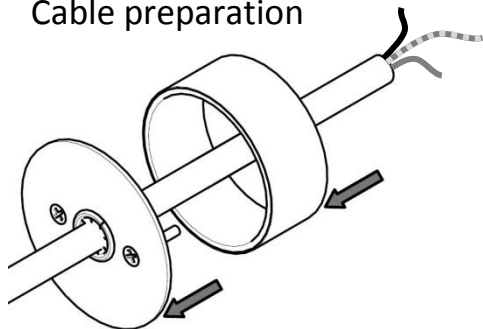

2.

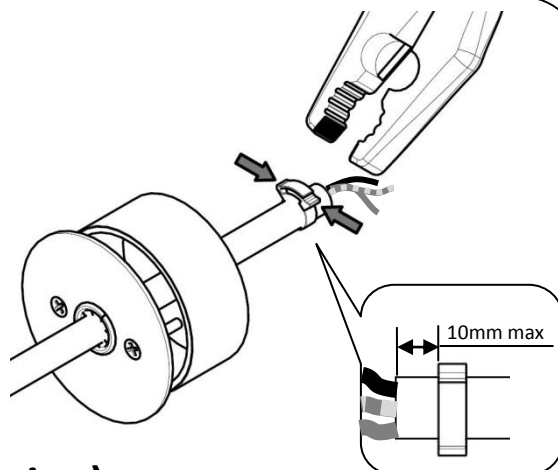

■ Préparation du mur (hors tension)

Wall preparation (switch off power supply)

3.

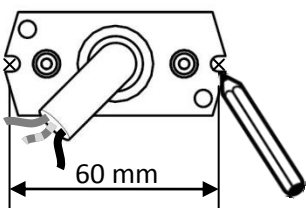

4.



5.

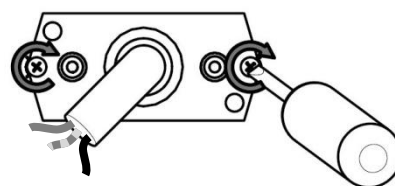

■ Raccordement (hors tension)

Electrical connection (switch off power supply)

6.

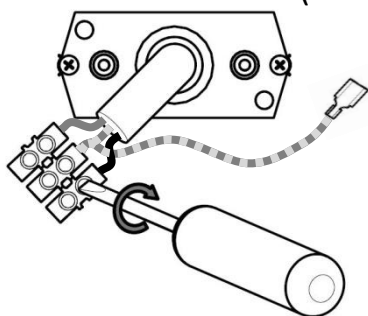

7.

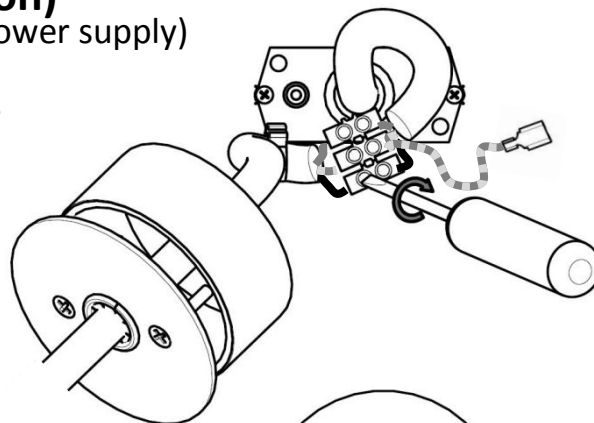

8.

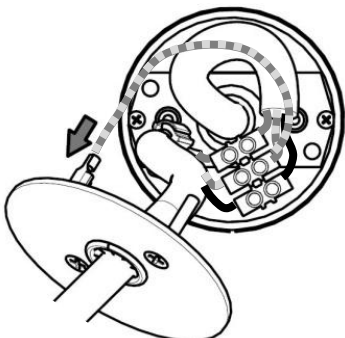

9.

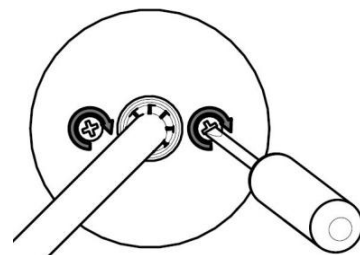

Pour câbles plus larges (>10mm)

For longer cables (>10mm)

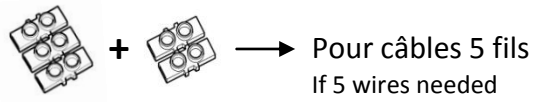
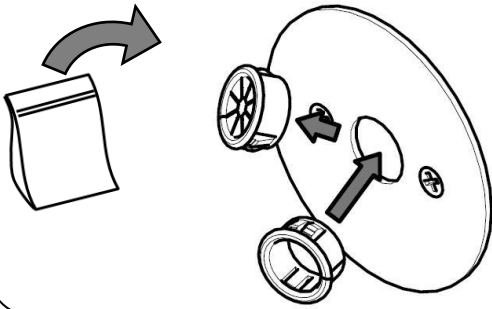

Ø8 → 9,2 Ø9,2 → 10,5 Ø10,2 → 12

